

WING KITCHEN

Parisotto+Formenton



COLORS AND MATERIALS COLORI E MATERIALI - COULEURS ET MATÉRIAUX

TOP
PIANO
PLATEAU

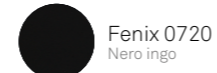
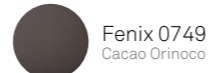
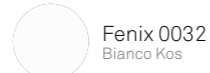

STRUCTURE AND LEGS
STRUTTURA E GAMBE
STRUCTURE ET PIEDS

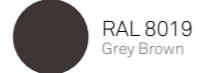
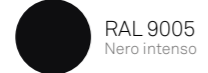

The standard finishings for the steel bases are the RAL shown above. Customized RAL colors are available upon request.

Le finiture standard delle basi in acciaio sono i RAL qui mostrati. Su richiesta sono disponibili colorazioni customizzate su altre tinte RAL.

Les finitions standard pour les socles en acier sont les RAL indiquées ci-dessus. Des finitions de couleurs RAL personnalisées sont disponibles sur demande.

TOP AND DRAWER
PIANO E CASSETTI - PLATEAU ET TIROIRS

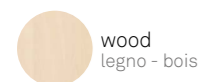

LEGS AND BEAM
GAMBE E TRAVE - PIEDS ET POUTRE

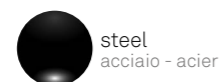

TECHNICAL FEATURES SPECIFICHE TECNICHE - SPÉCIFICATIONS TECHNIQUES

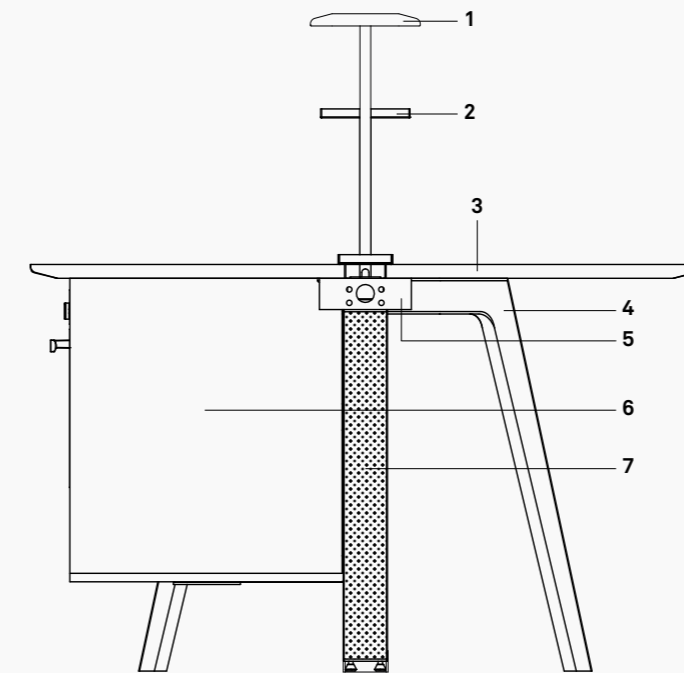

1. Led lamp with lacquered MDF structure

Lampada a led con struttura in MDF laccato
Lampe à LED avec structure en MDF laqué

2. Steel trays

Vassoi in acciaio
Plateaux en acier

3. Birch plywood top with Fenix veneer

Piano in multistrato di betulla impiallacciato fenix
Plateau en contreplaqué de bouleau avec placage Fenix

4. Steel legs

Gambe in acciaio
Pieds en acier

5. Steel beam

Trave in acciaio
Poutre en acier

6. Aluminum drawer with MDF front

Cassetto in alluminio con frontale in MDF
Tiroir en aluminium avec façade en MDF

7. Supporting column in perforated steel

Colonna portante in acciaio traforato
Colonne porteuse en acier perforé

Top in marine plywood Fenix® laminated, storage volumes in aluminum with lacquered MDF front. Frame, legs, beam and cable-guide columns in varnished steel.

Piano in multistrato marino Fenix® laminato, volumi di contenimento in alluminio con frontale in MDF laccato. Telaio, gambe, trave e colonne portacavi in acciaio verniciato.

Plateau en contreplaqué marin Fenix® laminé, volumes de rangement en aluminium avec façade MDF laquée. Cadre, pieds, poutres et colonnes de câbles en acier peint.

RAISED FLOOR PAVIMENTO RIALZATO - FAUX PLANCHER

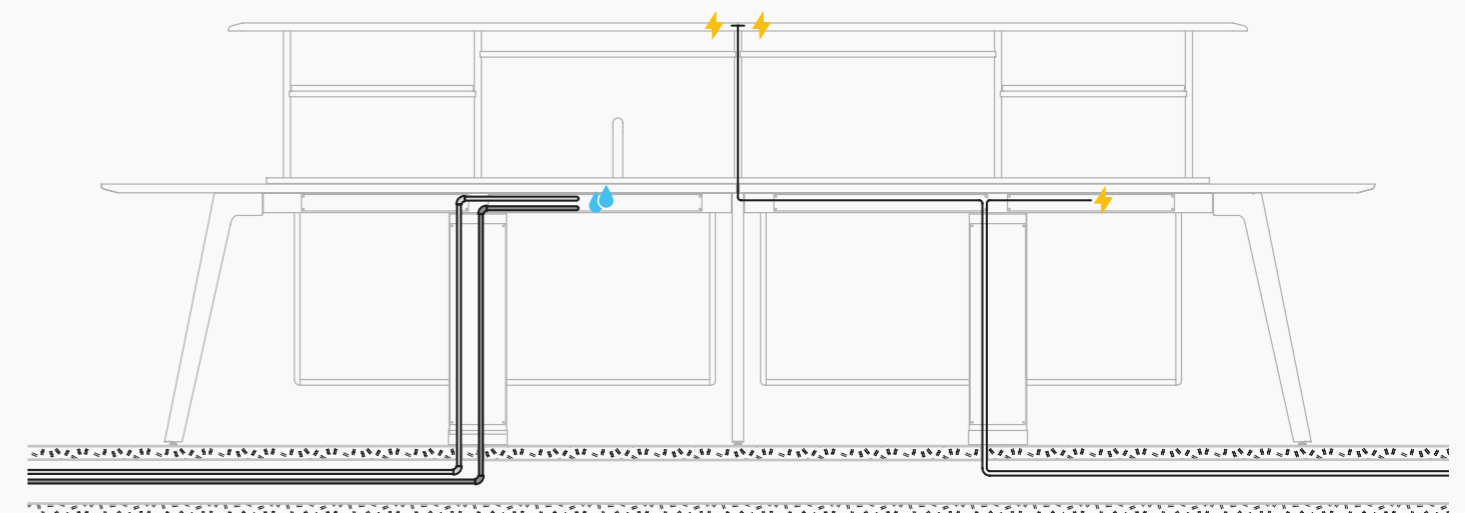

WING KITCHEN

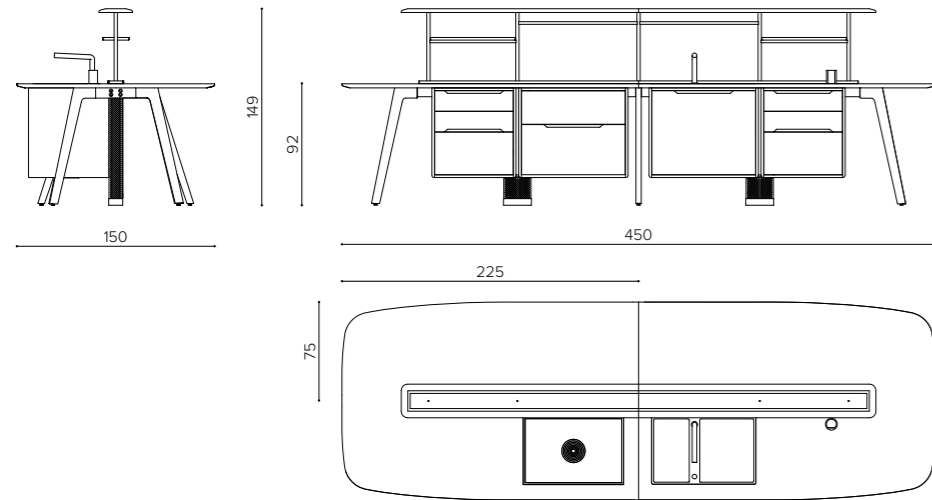

WI 450K

Wing kitchen 450x150 standard configuration

Wing Kitchen 450x150 configurazione standard
Wing Kitchen 450x150 configuration standard

STANDARD CONFIGURATION INCLUDED EQUIPMENT

CONFIGURAZIONE STANDARD EQUIPAGGIAMENTO INCLUSO - ÉQUIPEMENT DE CONFIGURATION STANDARD INCLUS

- LED lamp
Lampada a LED
Lampe à LED
- Induction hob + filtering aspirator
Piano cottura a induzione + aspiratore filtrante BORA
Plaque à induction + aspirateur filtrant BORA

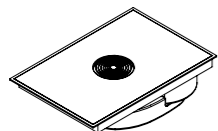

- Shelves
Mensole
Étagères
- Sink + Tap
Lavello + Rubinetto
Évier + Robinet

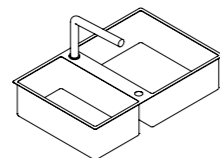

- Drawers with soft closing mechanism
Cassetti con chiusura ammortizzata
Tiroirs avec fermeture en douceur
- Power socket + 2x USB
Presa di corrente + 2x USB
Prise de courant + 2x USB

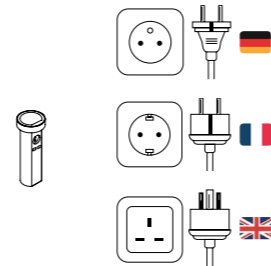

- Induction hob drawer
Cassetto piano cottura
Tiroir plaque à induction

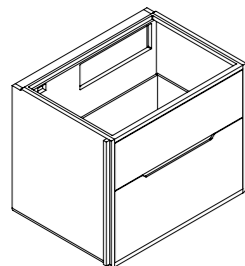

- Sink drawer
Cassetto lavello
Tiroir d'évier

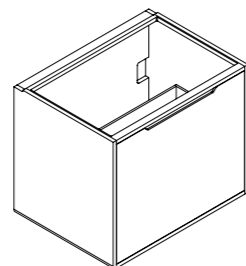

- Side drawer
Cassetto laterale
Tiroir latéral

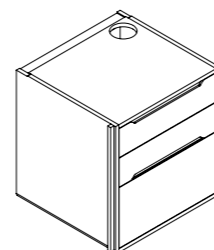

OPTIONAL EQUIPMENT

EQUIPAGGIAMENTO OPZIONALE - ÉQUIPEMENT OPTIONEL

- **WK**
V-ZUG combined steam oven
Forno a vapore combinato V-ZUG
Four mixte à vapeur V-ZUG

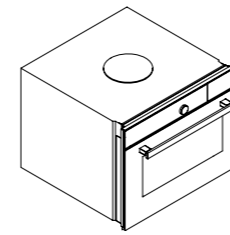

60 W x 60 D x 45 H

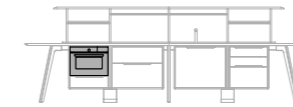

- **WK**
V-ZUG microwave oven
Forno a microonde V-ZUG
Four à micro-ondes V-ZUG

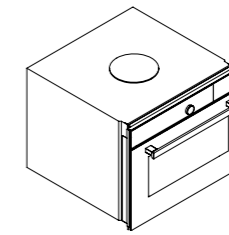

60 W x 60 D x 45 H

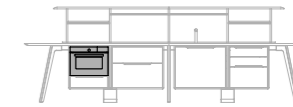

- **WK**
FreezyBoy waste collection device
Dispositivo per la raccolta di rifiuti FreezyBoy
Dispositif de collecte des déchets FreezyBoy

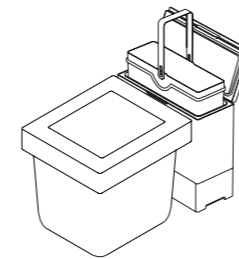

60 W x 45 D x 45 H

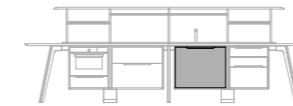

- **WK**
vacuum drawer
cassetto sottovuoto
tiroirs à vide

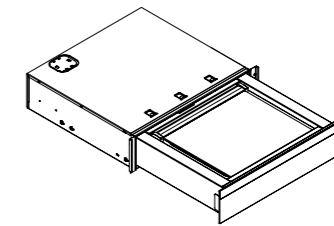

60 W x 55 D x 15 H

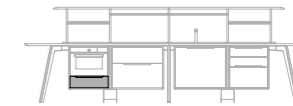

CHOPPING BOARDS
TAGLIERI - PLANCHE À DÉCOUPER

WK CH1512
chopping board
tagliere
planche à découper

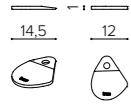

WK CH3915
chopping board
tagliere
planche à découper

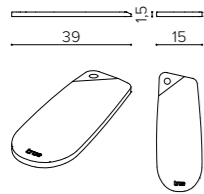

WK CH1516
chopping board
tagliere
planche à découper

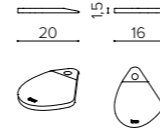

WK CH5323
chopping board
tagliere
planche à découper

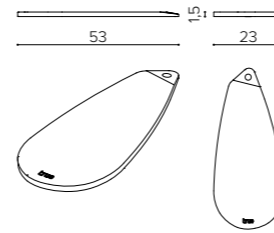

UPHOLSTERY CATEGORIES

CATEGORIE RIVESTIMENTI - CATÉGORIES DE TISSUS D'AMEUBLEMENT

S	camira	GRAVITY	76% Polyester, 24% Recycled Polyester, non metallic dyestuffs 76% Poliestere, 24% Poliestere riciclato, coloranti non metallici 76% Polyester, 24% Polyester recyclé, colorants non métalliques
	FIDIVI	LASER N	100% Polyester Trevira CS 100% Poliestere Trevira CS - 100% Polyester Trevira CS
	FIDIVI	ONE	100% Recycled polyester 100% Poliestere riciclato - 100% Polyester recyclé
T	FIDIVI	MAYA	100% Polyester Trevira CS 100% Poliestere Trevira CS - 100% Polyester Trevira CS
	FIDIVI	INCAS	100% Polyester Trevira CS 100% Poliestere Trevira CS - 100% Polyester Trevira CS
	FIDIVI	LASER J & J FLASH	100% Polyester Trevira CS 100% Poliestere Trevira CS - 100% Polyester Trevira CS
M	kvadrat	FIELD 2	100% Polyester Trevira CS 100% Poliestere Trevira CS - 100% Polyester Trevira CS
	FIDIVI	CORTE	100% Polyester Trevira CS 100% Poliestere Trevira CS - 100% Polyester Trevira CS
	camira	MAIN LINE FLAX	70% Virgin Wool, 30% Flax 70% Lana Vergine, 30% Lino - 70% Laine vierge, 30% Lin
	SPRADLING®	VALENCIA	Vinyl / Urethane Topcoat Finitura in vinile / uretano - Revêtement de finition vinyle / uréthane
F	camira	SYNERGY	95% Virgin Wool, 5% Polyamide 95% Lana Vergine, 5% Poliammide - 95% Laine vierge, 5% Polyamide
	kvadrat	REMIX 3	90% New wool (worsted), 10% Nylon 90% Lana vergine (pettinata), 10% Nylon - 90% Laine vierge (peignée), 10% Nylon
L	maharam	MERIT	76% Recycled polyester, 24% Polyester 76% Poliestere riciclato, 24% Poliestere - 76% Polyester recyclé, 24% Polyester
	kvadrat	MEMORY 2	100% Polyester Trevira CS 100% Poliestere Trevira CS - 100% Polyester Trevira CS
	kvadrat	COLLINE 2	75% New wool (worsted), 17% Acrylic, 8% Nylon 75% Lana vergine (pettinata), 17% Acrilico, 8% Nylon 75% Laine vierge (peignée), 17% Acrilico, 8% Nylon
P	DANI	PANAMA GENUINE LEATHER	Chrome tanned european bovine raw hides Pelle bovina europea ai sali di cromo - Cuir de bovin européenne avec sels de chrome
PX	FEBRIK kvadrat	UNIFORM MELANGE	European bovine leather, full grain Pelle pieno fiore, bovina europea - Cuir de bovin européen, pleine fleur
	elmo	BALTIQUE FULL GRAIN LEATHER	European bovine leather Pelle bovina europea - Cuir de bovin européen

OUTDOOR UPHOLSTERY CATEGORIES

CATEGORIE RIVESTIMENTI OUTDOOR - CATÉGORIES DE TISSUS D'AMEUBLEMENT OUTDOOR

M	SPRADLING®	MAGLIA	Vinyl / Urethane Topcoat Finitura in vinile / uretano - Revêtement de finition vinyle / uréthaneD
F	DELIUS WORLD OF TEXTILES SINCE 1722	GOA	100% Polyolefinic FR 100% Poliolefinico FR - 100% Polyoléfinique FR
	DELIUS WORLD OF TEXTILES SINCE 1722	TONGA	100% Polyolefinic FR 100% Poliolefinico FR - 100% Polyoléfinique FR
L	DELIUS WORLD OF TEXTILES SINCE 1722	ARUBA	100% Polyolefinic FR 100% Poliolefinico FR - 100% Polyoléfinique FR
	DELIUS WORLD OF TEXTILES SINCE 1722	BALI	100% Polyolefinic FR 100% Poliolefinico FR - 100% Polyoléfinique FR
	DELIUS WORLD OF TEXTILES SINCE 1722	HAITI	100% Polyolefinic FR 100% Poliolefinico FR - 100% Polyoléfinique FR

OUTDOOR USE AND MAINTENANCE

USO E MANUTENZIONE PER L'OUTDOOR - UTILISATION ET MAINTENANCE POUR L'EXTÉRIUR



STEEL
METALLO/MÉTAL

Steel is used in the manufacture of metal products. This material galvanised and powder-coated, is ideal for outdoor use. Regarding products intended for seaside locations we recommend cleaning on a quarterly basis, with a cloth using water or mild detergents. During the winter period we recommend storing the furniture in closed, dry rooms in order to prevent condensation. In fact, although our products are suitable for outdoor use, during colder months the products should be stored in a closed, dry place in order to prevent moisture and seasonal frosts from affecting the finish.

Nella realizzazione dei prodotti metallici viene impiegato l'acciaio, il quale in seguito al processo di zincatura e di verniciatura a polveri, risulta ideale per l'utilizzo outdoor. Durante il periodo invernale consigliamo di conservare gli arredi in luoghi chiusi ed asciutti per evitare la formazione di condensa. Per i prodotti destinati a località marittime consigliamo con cadenza trimestrale una pulizia con un panno utilizzando acqua o detersivi non aggressivi. Nonostante i nostri prodotti siano adatti all'ambiente esterno, durante il periodo invernale è consigliato il ricovero dei prodotti in un luogo chiuso ed asciutto. In modo da evitare che l'umidità unita alle gelate stagionali possa in qualche modo intaccare le finiture.

L'acier est la matière première utilisée dans la fabrication de ces produits métalliques qui, après un processus de galvanisation et un revêtement de finition par poudre, sont idéaux pour une utilisation en extérieur. Pour les produits destinés à être utilisés en bord de mer, nous recommandons un nettoyage trimestriel avec un chiffon utilisant de l'eau ou des détergents doux. Bien que nos produits soient adaptés à un usage extérieur, nous recommandons de les stocker dans un endroit fermé et sec pendant l'hiver; ceci afin d'éviter que l'humidité combinée aux gelées saisonnières n'affecte d'une manière ou d'une autre les finitions.

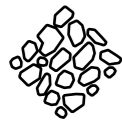

STONE
PIETRA/PIERRE

The stone tops are made of Marble or Quarella and they are ideal for the outdoor environment. Use a soft cloth with just water for daily cleaning. Avoid the use of aggressive abrasive sponges or steel wool pads. The furnishings made of stone such as marble and Quarella, during the first week of use will undergo a slight dulling due to contact with external elements. This is a natural phenomenon which does not affect the quality of the material. When the furniture is placed in seaside locations or swimming pools, cleaning with fresh water on a quarterly basis is recommended in order to avoid water corrosion due to salt build-up or chlorosis. Although our products are suitable for outdoor use, during colder months the products should be stored in a closed, dry place in order to prevent moisture and seasonal frosts from affecting the finish.

Materiale composito autoportante adatto all'ambiente Outdoor. Utilizzare un panno morbido con sola acqua per la pulizia quotidiana. In caso di necessità utilizzare detersivi non aggressivi. Evitare l'impiego di spugne abrasive o pagliette in acciaio. Nel caso di collocamento degli arredi in località marittime o piscine, si consiglia una pulizia trimestrale utilizzando acqua dolce per evitare principi di corrosione dovuti ad accumuli salini o clorosi. Nonostante i nostri prodotti siano adatti all'ambiente esterno, durante il periodo invernale è consigliato il ricovero dei prodotti in un luogo chiuso ed asciutto. In modo da evitare che l'umidità unita alle gelate stagionali possa in qualche modo intaccare le finiture.

Les dessus en pierre sont en marbre ou en quarella, idéaux pour une utilisation en extérieur. Utilisez un chiffon doux avec de l'eau uniquement pour le nettoyage quotidien. Évitez d'utiliser des détergents agressifs, des éponges abrasives ou des tampons de laine d'acier. Les meubles en pierre tels que le marbre et la Quarella, pendant la première semaine, subissent un léger ternissement dû au contact avec les éléments extérieurs. Il s'agit d'un phénomène naturel, qui n'affecte pas la qualité du matériau. Si le meuble est placé dans des stations balnéaires ou des piscines, nous recommandons un nettoyage trimestriel à l'eau douce pour éviter la corrosion due à l'accumulation de sel ou à la chlorose. Bien que nos produits conviennent à une utilisation en extérieur, il est recommandé, pendant la période hivernale, de stocker les produits dans un endroit fermé et sec, afin d'éviter que l'humidité combinée aux gelées saisonnières n'affecte d'une manière ou d'une autre la finition.



FABRICS
PIETRA/TISSU

The fabrics used are naturally resistant to climatic elements, UV-resistant and anti-microbial. After heavy rainfall it is recommended to remove the cushions for quick drying and in order to prevent condensation. When the furniture is placed in seaside locations or swimming pools, cleaning with fresh water on a quarterly basis is recommended in order to avoid water corrosion due to salt build-up or chlorosis. Although our products are suitable for outdoor use, during colder months the products should be stored in a closed, dry place in order to prevent moisture and seasonal frosts from affecting the finish.

I tessuti impiegati sono naturalmente resistenti agli elementi climatici, resistenti ai raggi UV ed anti-microbici. A seguito di forti precipitazioni è consigliato rimuovere i cuscini per un'asciugatura rapida e prevenire la formazione di condensa. Nel caso di collocamento degli arredi in località marittime o piscine, si consiglia una pulizia trimestrale utilizzando acqua dolce per evitare principi di corrosione dovuti ad accumuli salini o clorosi. Nonostante i nostri prodotti siano adatti all'ambiente esterno, durante il periodo invernale è consigliato il ricovero dei prodotti in un luogo chiuso ed asciutto. In modo da evitare che l'umidità unita alle gelate stagionali possa in qualche modo intaccare le finiture.

Les tissus utilisés sont naturellement résistants aux éléments climatiques, résistants aux UV et antimicrobiens. Après de fortes pluies, il est toutefois conseillé de retirer les coussins pour un séchage rapide et pour éviter la formation de condensation. Si le mobilier est placé dans des stations balnéaires ou des piscines, nous recommandons un nettoyage trimestriel à l'eau douce pour éviter la corrosion due à l'accumulation de sel ou de chlore. Bien que nos produits soient adaptés à une utilisation en extérieur, il est recommandé de les stocker dans un endroit fermé et sec pendant la période hivernale, afin d'éviter que l'humidité combinée aux gelées saisonnières n'affecte d'une manière ou d'une autre les finitions.

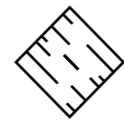

HPL
HPL/HPL

Self-supporting composite material suitable for outdoor environment. Use a soft cloth with water only for daily cleaning. If necessary, use non-aggressive detergents. Please avoid using abrasive sponges or steel wool pads. When the furniture is placed in seaside locations or swimming pools, cleaning with fresh water on a quarterly basis is recommended in order to avoid water corrosion due to salt build-up or chlorosis. Although our products are suitable for outdoor use, during colder months the products should be stored in a closed, dry place in order to prevent moisture and seasonal frosts from affecting the finish.

Materiale composito autoportante adatto all'ambiente Outdoor. Utilizzare un panno morbido con sola acqua per la pulizia quotidiana. In caso di necessità utilizzare detersivi non aggressivi. Evitare l'impiego di spugne abrasive o pagliette in acciaio. Nel caso di collocamento degli arredi in località marittime o piscine, si consiglia una pulizia trimestrale utilizzando acqua dolce per evitare principi di corrosione dovuti ad accumuli salini o clorosi. Nonostante i nostri prodotti siano adatti all'ambiente esterno, durante il periodo invernale è consigliato il ricovero dei prodotti in un luogo chiuso ed asciutto. In modo da evitare che l'umidità unita alle gelate stagionali possa in qualche modo intaccare le finiture.

Matériau composite autoportant adapté à un usage extérieur. Utilisez un chiffon doux avec de l'eau uniquement pour le nettoyage quotidien. Si nécessaire, utilisez des détergents non agressifs. Évitez d'utiliser des éponges abrasives ou des tampons de laine d'acier. Si le mobilier doit être installé dans des stations balnéaires ou des piscines, nous recommandons un nettoyage trimestriel à l'eau douce pour éviter la corrosion due au sel ou au chlore. Bien que nos produits conviennent à une utilisation en extérieur, il est recommandé, pendant la période hivernale, de stocker les produits dans un endroit fermé et sec, afin d'éviter que l'humidité combinée aux gelées saisonnières n'affecte d'une manière ou d'une autre les finitions.

STANDARD STEEL RAL COLORS

COLORI RAL STANDARD PER ACCIAIO - COULEURS RAL STANDARD POUR L'ACIER

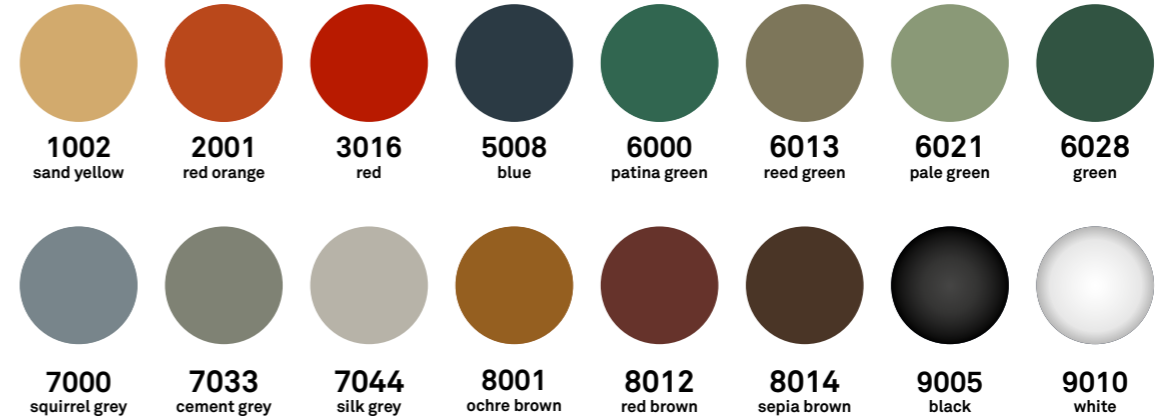

The standard finishings for the steel elements are the RAL shown. Customized RAL colors finishings are available upon request.

Le finiture standard degli elementi in acciaio sono i RAL mostrati. Su richiesta sono disponibili colorazioni customizzate su altre tinte RAL.

Les finitions standard des éléments en acier sont le RAL illustré. Des couleurs RAL personnalisées sont disponibles sur demande.



COLOR SWATCHES AND TECH INFO

CAMPIONI COLORI E INFO TECNICHE - ÉCHANTILLONS DE COULEURS ET INFOS TECHNIQUES

DOWNLOAD

Click on the image above to download the color swatches and technical informations

Clicca sull'immagine per scaricare il pdf dei campioni colori e specifiche tecniche

Cliquez sur l'image ci-dessus pour télécharger les échantillons de couleurs et les informations techniques

